

HFA80NC40CSL

HEXFRED™

Ultrafast, Soft Recovery Diode

Features

- Reduced RFI and EMI
- Reduced Snubbing
- Extensive Characterization of Recovery Parameters

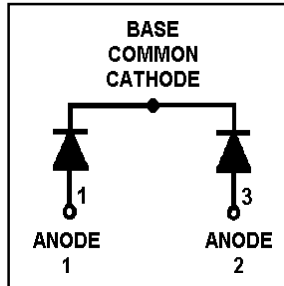

$V_R = 400V$
$V_F(\text{typ.})^{\textcircled{3}} = 1V$
$I_{F(AV)} = 80A$
$Q_{rr}(\text{typ.}) = 200nC$
$I_{RRM}(\text{typ.}) = 6A$
$t_{rr}(\text{typ.}) = 30ns$
$di_{(rec)M}/dt(\text{typ.})^{\textcircled{3}} = 190A/\mu s$

Description

HEXFRED™ diodes are optimized to reduce losses and EMI/RFI in high frequency power conditioning systems. An extensive characterization of the recovery behavior for different values of current, temperature and di/dt simplifies the calculations of losses in the operating conditions. The softness of the recovery eliminates the need for a snubber in most applications. These devices are ideally suited for power converters, motors drives and other applications where switching losses are significant portion of the total losses.

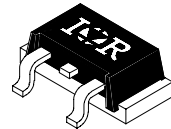

SLD-61-8

Absolute Maximum Ratings (per Leg)

	Parameter	Max.	Units
V_R	Cathode-to-Anode Voltage	400	V
$I_F @ T_C = 25^\circ C$	Continuous Forward Current	85	A
$I_F @ T_C = 100^\circ C$	Continuous Forward Current	42	
I_{FSM}	Single Pulse Forward Current ①	300	
E_{AS}	Non-Repetitive Avalanche Energy ②	1.4	mJ
$P_D @ T_C = 25^\circ C$	Maximum Power Dissipation	150	W
$P_D @ T_C = 100^\circ C$	Maximum Power Dissipation	59	
T_J	Operating Junction and	-55 to +150	°C
T_{STG}	Storage Temperature Range		
	Soldering Temperature, for 10 sec.	300 (0.063 in. (1.6mm) from case)	

Thermal - Mechanical Characteristics

	Parameter	Min.	Typ.	Max.	Units
R_{thJC}	Junction-to-Case, Single Leg Conducting	—	—	0.85	°C/W
	Junction-to-Case, Both Legs Conducting	—	—	0.42	K/W
Wt	Weight	—	4.3 (0.15)	—	g (oz)

Note: ① Limited by junction temperature
 ② L = 100μH, duty cycle limited by max T_J
 ③ 125°C

Electrical Characteristics (per Leg) @ $T_J = 25^\circ\text{C}$ (unless otherwise specified)

Parameter	Min.	Typ.	Max.	Units	Test Conditions
V_{BR}	400	—	—	V	$I_R = 100\mu\text{A}$
V_{FM}	—	1.1	1.3	V	$I_F = 40\text{A}$
	—	1.3	1.5		$I_F = 80\text{A}$ See Fig. 1
	—	1.0	1.2		$I_F = 40\text{A}, T_J = 125^\circ\text{C}$
I_{RM}	—	0.50	3.0	μA	$V_R = V_R$ Rated
	—	0.75	4.0	mA	$T_J = 125^\circ\text{C}, V_R = 320\text{V}$ See Fig. 2
C_T	—	90	125	pF	$V_R = 200\text{V}$ See Fig. 3
L_S	—	5.5	—	nH	Lead to lead 5mm from package body

Dynamic Recovery Characteristics (per Leg) @ $T_J = 25^\circ\text{C}$ (unless otherwise specified)

Parameter	Min.	Typ.	Max.	Units	Test Conditions
t_{rr}	—	30	—	ns	$I_F = 1.0\text{A}, di/dt = 200\text{A}/\mu\text{s}, V_R = 30\text{V}$
t_{rr1}	—	67	100		$T_J = 25^\circ\text{C}$ See Fig. 5
t_{rr2}	—	110	170		$T_J = 125^\circ\text{C}$
I_{RRM1}	—	6.0	11	A	$T_J = 25^\circ\text{C}$ See Fig. 6
I_{RRM2}	—	9.0	16		$T_J = 125^\circ\text{C}$
Q_{rr1}	—	200	540	nC	$T_J = 25^\circ\text{C}$ See Fig. 7
Q_{rr2}	—	500	1300		$T_J = 125^\circ\text{C}$
$di_{(rec)M}/dt1$	—	240	—	$\text{A}/\mu\text{s}$	$T_J = 25^\circ\text{C}$ See Fig. 8
$di_{(rec)M}/dt2$	—	190	—		$T_J = 125^\circ\text{C}$

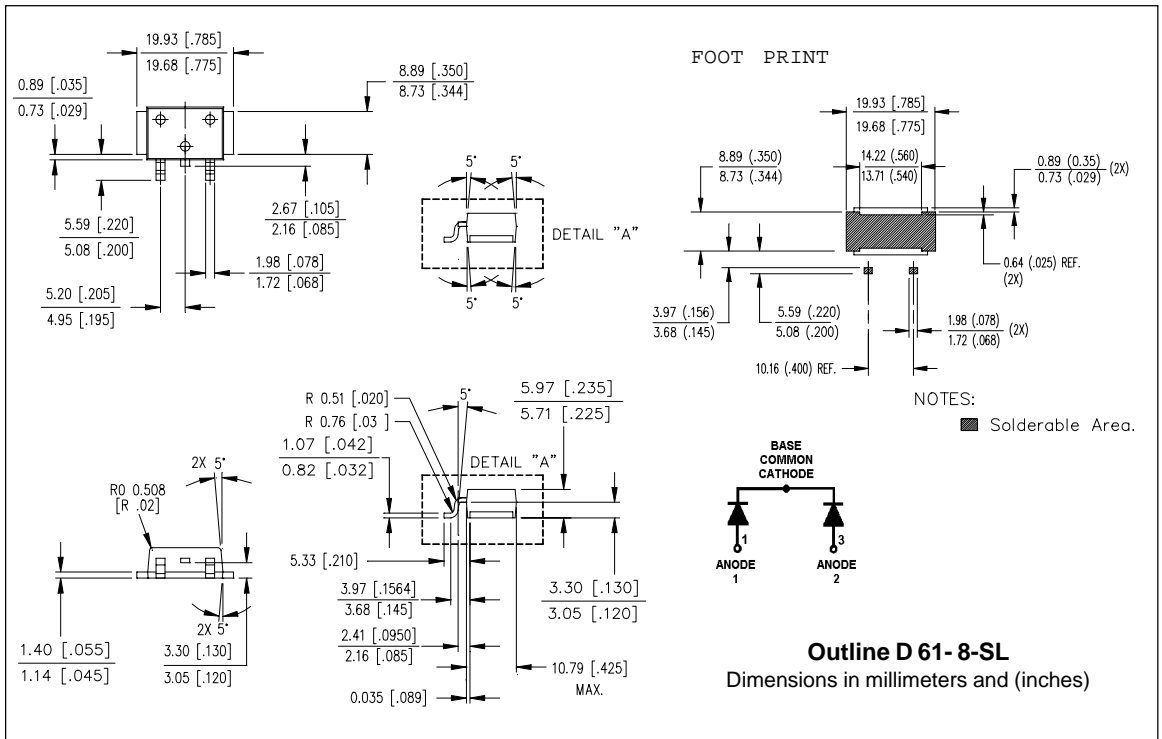

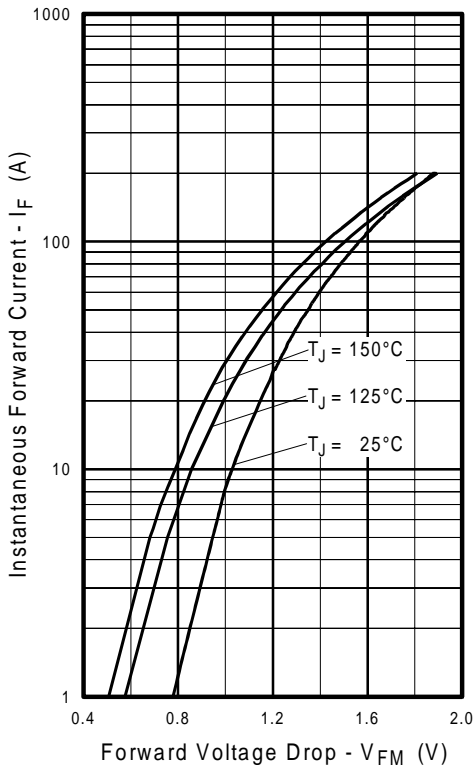

Fig. 1 - Maximum Forward Voltage Drop vs. Instantaneous Forward Current, (per Leg)

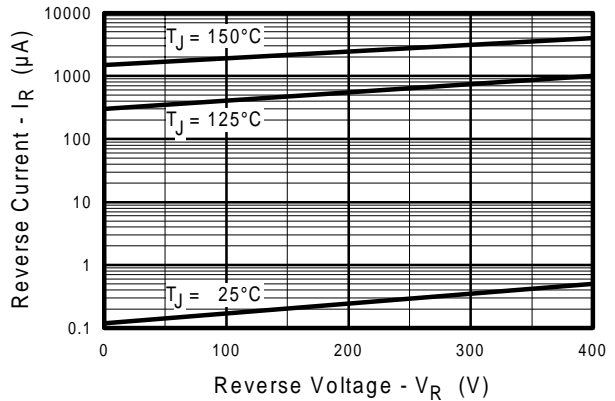

Fig. 2 - Typical Reverse Current vs. Reverse Voltage, (per Leg)

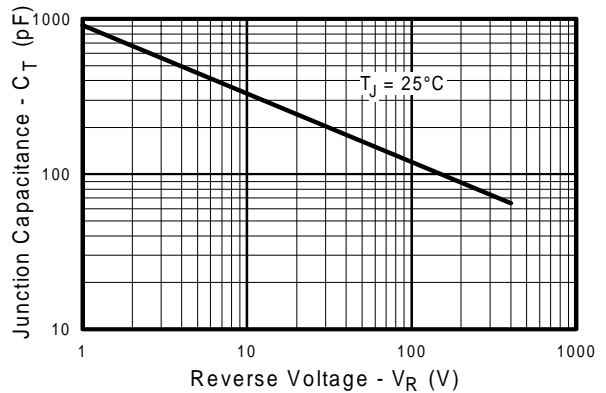

Fig. 3 - Typical Junction Capacitance vs. Reverse Voltage, (per Leg)

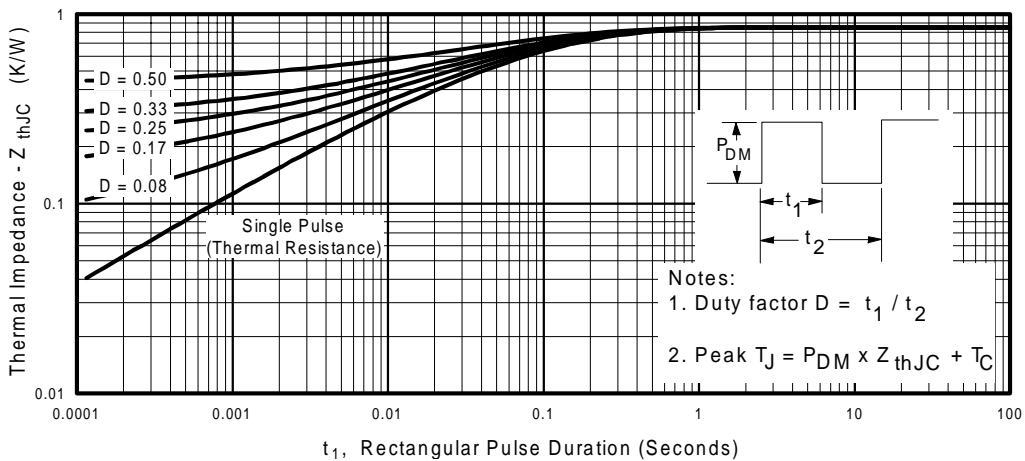

Fig. 4 - Maximum Thermal Impedance Z_{thJC} Characteristics, (per Leg)

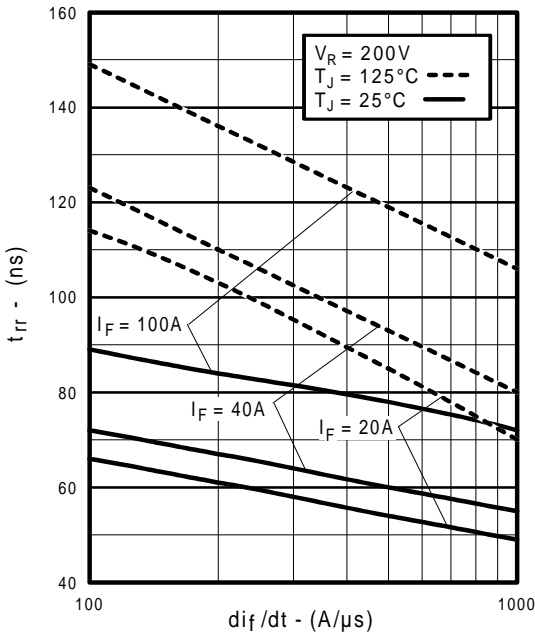

Fig. 5 - Typical Reverse Recovery vs. di_f/dt , (per Leg)

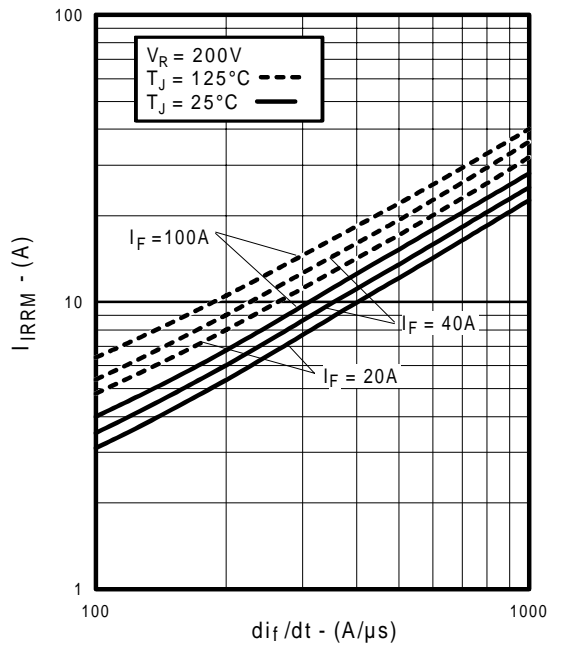

Fig. 6 - Typical Recovery Current vs. di_f/dt , (per Leg)

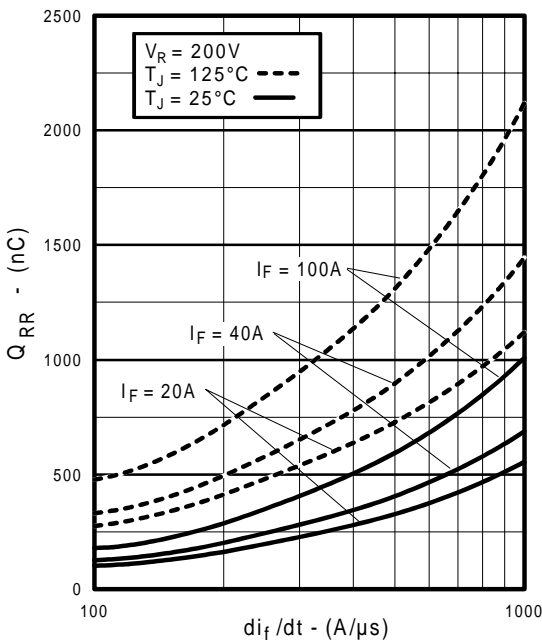

Fig. 7 - Typical Stored Charge vs. di_f/dt , (per Leg)

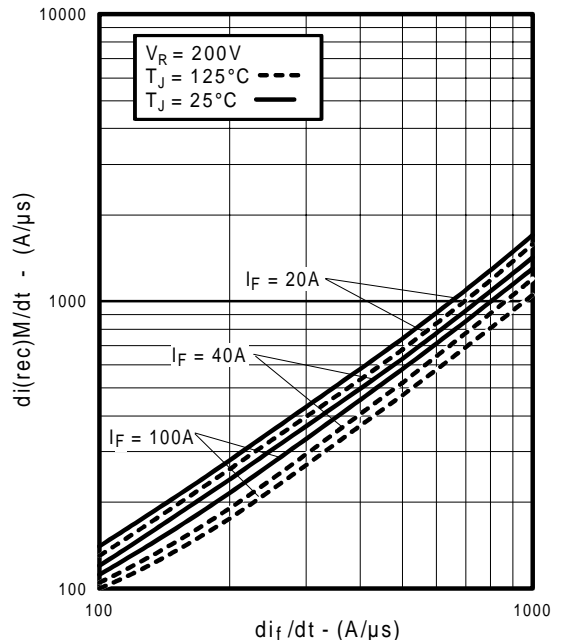

Fig. 8 - Typical $di_{(rec)}M/dt$ vs. di_f/dt , (per Leg)

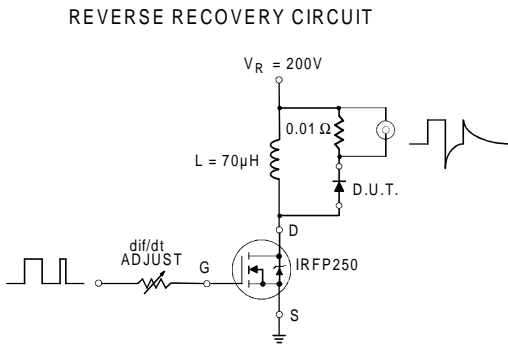
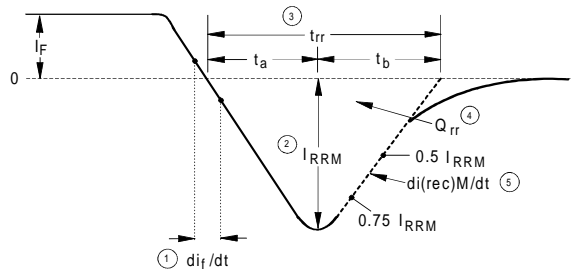

Fig. 9 - Reverse Recovery Parameter Test Circuit



1. di_f/dt - Rate of change of current through zero crossing
2. I_{RRM} - Peak reverse recovery current
3. t_{rr} - Reverse recovery time measured from zero crossing point of negative going I_F to point where a line passing through $0.75 I_{RRM}$ and $0.50 I_{RRM}$ extrapolated to zero current
4. Q_{rr} - Area under curve defined by t_{rr} and I_{RRM}
5. $di_{(rec)M}/dt$ - Peak rate of change of current during t_b portion of t_{rr}

$$Q_{rr} = \frac{t_{rr} \times I_{RRM}}{2}$$

Fig. 10 - Reverse Recovery Waveform and Definitions

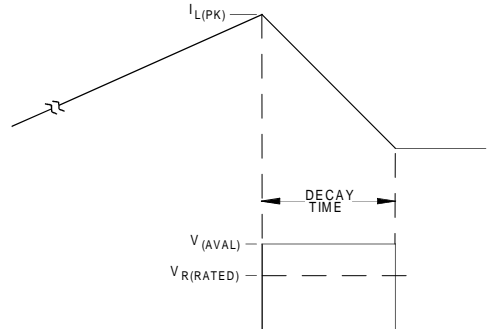
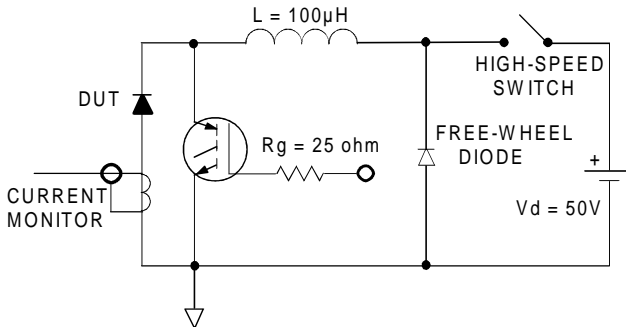

Fig. 11 - Avalanche Test Circuit and Waveforms